

# ATELIER ARETI

## PRODUCT

Fan 565  
Pendant light / Short

## MATERIALS AND COLOUR OPTIONS

Brushed brass; white glass

## VERSIONS

Brushed brass structure	565OL-P01-BR01
Nickel structure	565OL-P01-NI01
Black structure	565OL-P01-ME01
White structure	565OL-P01-ME02
Coloured structure	565OL-P01-ME03

## TECHNICAL DETAILS

9 x G9 LED 5W max  
110-230V  
IP20  
Light bulbs not included

## WEIGHT

12 kg

## MADE IN

Germany

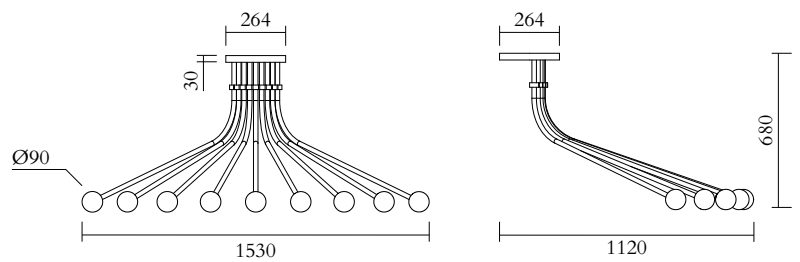

Sizes in mm. Flat attachments available on request. Variations in colour and size are available for some collections, please contact Areti for more details.

Our collections are hand made and made to order, small irregularities in shape or surface will occur, they are inherent to the hand made process and should not be seen as flaws. For detailed information on any products: [contact@atelierareti.com](mailto:contact@atelierareti.com)

# ATELIER ARETI

## PRODUCT

Fan 565  
Pendant light / Medium

## MATERIALS AND COLOUR OPTIONS

Brushed brass; white glass

## VERSIONS

Brushed brass structure	565OL-P02-BR01
Nickel structure	565OL-P02-NI01
Black structure	565OL-P02-ME01
White structure	565OL-P02-ME02
Coloured structure	565OL-P02-ME03

## TECHNICAL DETAILS

9 x G9 LED 5W max  
110-230V  
IP20  
Light bulbs not included

## WEIGHT

15 kg

## MADE IN

Germany

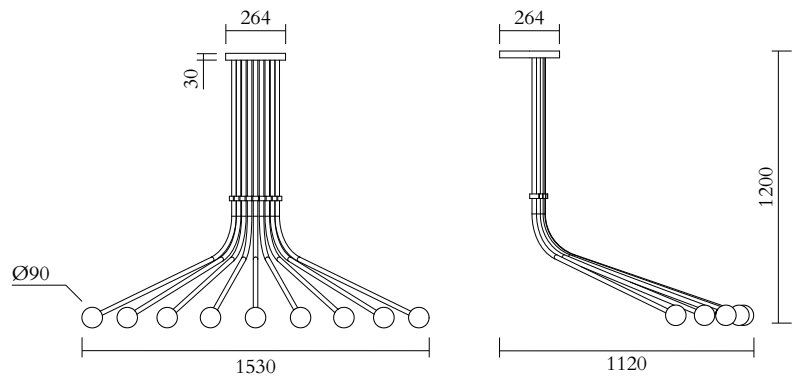

Sizes in mm. Flat attachments available on request. Variations in colour and size are available for some collections, please contact Areti for more details.

Our collections are hand made and made to order, small irregularities in shape or surface will occur, they are inherent to the hand made process and should not be seen as flaws. For detailed information on any products: [contact@atelierareti.com](mailto:contact@atelierareti.com)

# ATELIER ARETI

## PRODUCT

Fan 565  
Pendant light / Long

## MATERIALS AND COLOUR OPTIONS

Brushed brass; white glass

## VERSIONS

Brushed brass structure	565OL-P03-BR01
Nickel structure	565OL-P03-NI01
Black structure	565OL-P03-ME01
White structure	565OL-P03-ME02
Coloured structure	565OL-P03-ME03

## TECHNICAL DETAILS

9 x G9 LED 5W max  
110-230V  
IP20  
Light bulbs not included

## WEIGHT

18 kg

## MADE IN

Germany

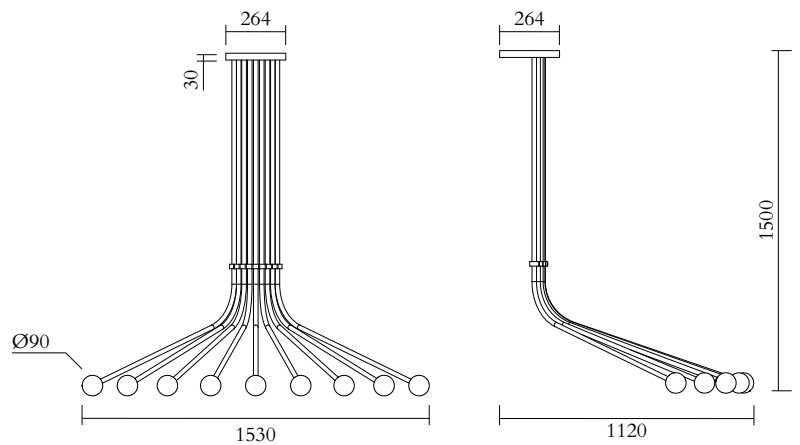

Sizes in mm. Flat attachments available on request. Variations in colour and size are available for some collections, please contact Areti for more details.

Our collections are hand made and made to order, small irregularities in shape or surface will occur, they are inherent to the hand made process and should not be seen as flaws. For detailed information on any products: [contact@atelierareti.com](mailto:contact@atelierareti.com)

# ATELIER ARETI

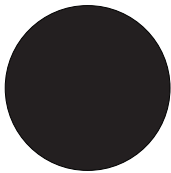

01  
Black

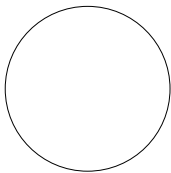

02  
White

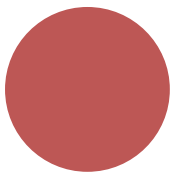

03  
Red

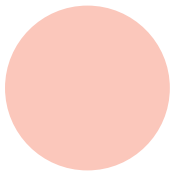

04  
Pink

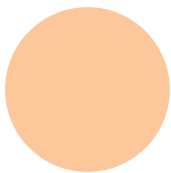

05  
Sand

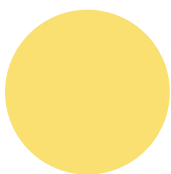

06  
Light yellow



07  
Intense yellow

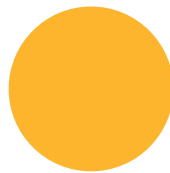

08  
Orange yellow

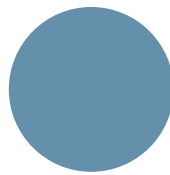

09  
Blue

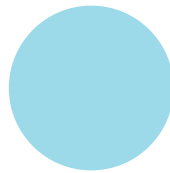

10  
Light blue

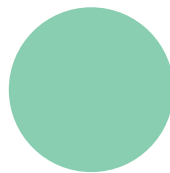

11  
Light green

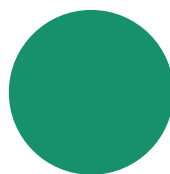

12  
Intense green